

OWNER'S MANUAL

Evaporative Cooler

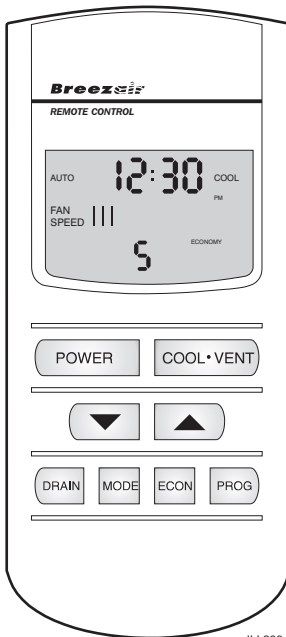

ILL239-D

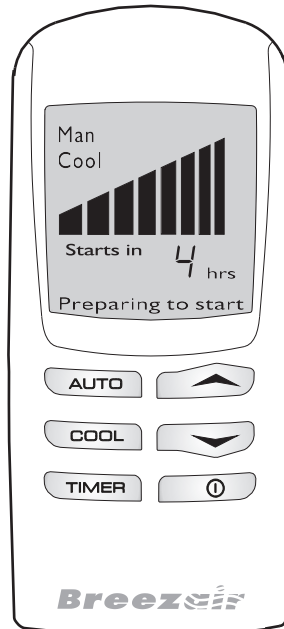

ILL1140-A

(English) (EA, EXH, EZH)

Hello and congratulations on purchasing a Breezair® Ducted Cooler for your home.

Breezair® coolers have been designed to provide quiet, reliable and cool comfort.

At Seeley International we manufacture Breezair® evaporative coolers from the highest quality materials, and we have designed the product to provide many years of economical, trouble free cooling.

Please take a few moments to read these operating instructions, so that the most can be gained from this investment.

Breezair® coolers are fitted with either a Wall Mounted Thermostat Control or a Remote Thermostat Control. Please refer to the relevant section in this manual for instructions on how to operate either system. Also, please be aware of the components and features that are fitted to your particular cooler.

Keep these instructions in a safe place for future reference.

The appliance is not intended for use by persons (including children) with reduced physical, sensory or mental capabilities, or lack of experience and knowledge, unless they have been given supervision or instruction concerning the use of the appliance by a person responsible for their safety.

EFFECTIVE COOLING

To provide efficient cooling or ventilation the building must have sufficient exhaust openings to the outside of the building. To assist air flow, open windows and doors that are farthest from the outlet vent in each room. In these rooms, provide an exhaust opening about 2 times the vent size of the room.

Where the design of the building prevents adequate exhaust, consideration should be given to the provision of mechanical extractions, such as an exhaust fan.

Important Notes!

In areas where temperatures can cause water supply pipes to freeze, a drain down facility should be provided during the installation. This drain down facility must be activated prior to freezing conditions, to avoid possible damage to the cooler components.

If the supply cord is damaged, it must be replaced with a special cord available from the manufacturer or its service agents.



ILL239-D

Remote Thermostat Control
(remote control)

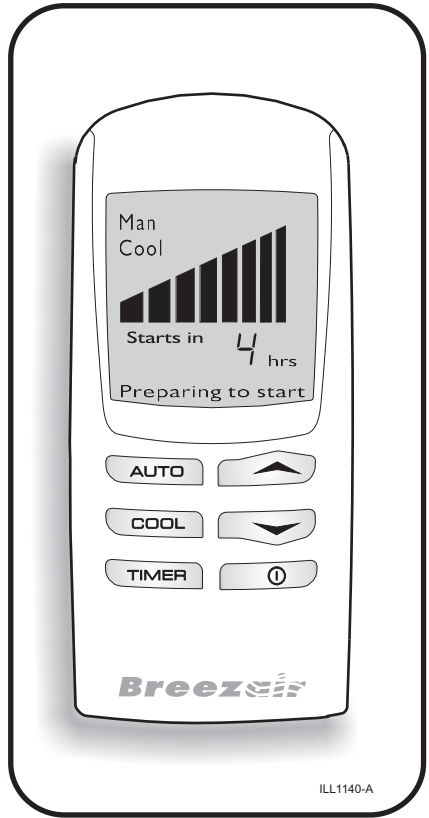

ILL1140-A

Wall Mounted Thermostat Control
(wall control)

Remote Thermostat Control5

Wall Mounted Thermostat Control ..11

Bleed Funnel & Drain Valve15

Power Outages15

Seasonal Maintenance16

Troubleshooting18

Service & Warranty20

SETTING THE CLOCK

Set the clock on the remote control before proceeding with any other programming.

The clock can only be set with the remote control switched OFF. Hold the **PROG** button down for over 2 seconds, until the hour flashes. The clock can be set to either 12 or 24 hours (see page 10). If the clock is set to 12 hours make sure that the AM/PM displayed on the screen is correct. AM/PM will change with adjustment of the hour.



ILL1104-A

Use the **▼** and **▲** buttons to change the hour. To change minutes, press the **PROG** button again. Change the minutes using the **▼** and **▲** buttons.

To lock in the time setting, and enter the OFF state, press the **PROG** button. The display will stop flashing.

TURNING ON THE COOLER

The remote control is switched on and off using the **POWER** button. The memory will store and use the settings from when the cooler was last used. Once the remote control is on, you can choose between MANUAL, AUTO and AUTO TIMER modes by pressing the **MODE** button.

MANUAL MODE

With the remote control ON, press the **MODE** button until MANUAL is shown in the top left corner of the display.



ILL1108-A

The **COOL-VENT** button is used to select VENT (where fresh air is being delivered without being cooled) or COOL.



ILL1109-A

Once either COOL or VENT has been selected, the remote control will maintain a constant fan speed. This is indicated by the bar graph in the centre of the display.

To decrease or increase the fan speed required, press either the **▼** or **▲** buttons.

AUTO MODE



The remote control contains a thermostat. In AUTO mode the cooler is controlled automatically, based on your pre-selected comfort level. The cooler will adjust the fan speed, switch between COOL and VENT and turn itself off. However, the sequence and regularity at which these settings change will differ with each operation of the cooler.

As the remote control senses room conditions, the comfort control settings will be influenced by heat from direct sunlight or electrical appliances. Likewise placing the remote control in cupboards or drawers or under cooling vents will affect the cooler's operation.

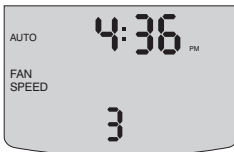
To set the AUTO mode press the  button until AUTO is displayed.



ILL1105-A

Ten levels of comfort are available with the remote control. While in AUTO mode pressing the  and  buttons will adjust the level of required comfort. The display will show your selection by indicating a level between 1 and 10. WARMER or COOLER will be displayed on the screen as settings are changed.

AUTO TIMER MODE



AUTO TIMER mode can be selected by using the  button. Once the AUTO TIMER mode is selected the cooler will only operate during the programmed time period.

Programming the timer must be performed before AUTO TIMER can be activated. This can be done while in any mode, even when it is OFF. There are 7 steps involved in setting the AUTO TIMER.

NOTE: After pressing the  button the display will revert back to the previous setting if no buttons are pressed within 4 seconds.

To program the timer use the following sequence:

(1) Setting the ON time hour

Begin by pressing the  button. The hour displayed will start flashing and the word ON will appear on the screen. Then use the  and  buttons to change the hour value.



ILL1112-A

(2) Setting the ON time minutes

Press the **PROG** button. The minutes displayed will start flashing and the word ON will appear on the screen. Then use the **▼** and **▲** buttons to change the minute setting.

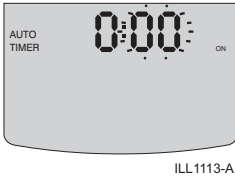

(3) Setting the OFF time hour

Press the **PROG** button. The hour displayed will start flashing and OFF will be displayed. Then use the **▼** and **▲** buttons to change the hour.

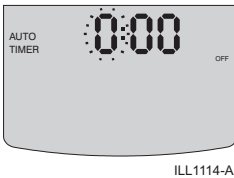

(4) Setting the OFF time minutes

Press the **PROG** button. The minutes displayed will start flashing and the word OFF will appear. Then use the **▼** and **▲** buttons to change the minute setting.

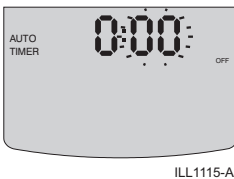

(5) Setting the comfort level

Press the **PROG** button and the comfort level number (1 to 10) displayed will start flashing. Then use the **▼** and **▲** buttons to change this setting.

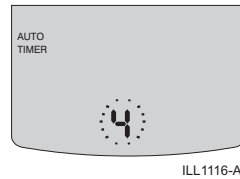

(6) Setting ECONOMY

To select economy press the **ECON** button so that it is displayed on the screen.

(7) Activating AUTO TIMER

Now that you have programmed the settings for AUTO TIMER they will be stored in the remote control's memory until you change them. Press the **MODE** button until AUTO TIMER is displayed on the screen. Your cooler will now only operate during the programmed time period.

NOTE: To change any AUTO TIMER settings when the remote control is switched off, the **PROG** button needs to be pressed and released within 1 second. To change settings when the remote control is turned on press the **PROG** button until the desired number is flashing.

ECONOMY MODE

Selecting the ECONOMY mode limits the maximum available cooling or ventilation and reduces the power used by up to 20%. The ECONOMY function can be used in either AUTO or MANUAL modes. To select this mode press the  button so that ECONOMY appears on the display.



ILL1125-A

DRAIN MODE

Pressing the  button opens the drain valve in the cooler and empties the water in the tank. This will leave the tank clean and dry and turn the cooler off.



ILL1107-A

If the cooler has not been used for 3 days or 3 hours, depending on the DIP switch setting - see page 10, the tank will automatically be drained to ensure the system remains clean.

PRE - COOL MODE

Your remote control is designed to allow for the saturation of the cooler's cooling pads before the fan is switched on. This function, referred to as PRE-COOL mode, is enabled at DIP switch D (refer to page 10). Once it is enabled the cooler, when first switched on, will operate as follows:

- (1)..... If the tank is empty the drain system will be closed. The tank will then be filled.
- (2)..... After 60 seconds of the tank filling with water, the pump will turn on and saturate the filter pads.
- (3)..... After the pump has been running for 3 minutes the fan will start.

During this operation the word PRE-COOL will be displayed on the remote control's screen.



ILL1142-A

NOTE: PRE-COOL mode will not be activated if VENT is selected on the remote control or the cooler is used again shortly after having been turned off.

WATER MANAGER®

The Breezair® remote control is fitted with the WaterManager® feature which automatically monitors the quality of the water in the cooler.

The WaterManager® drains the existing water in the cooler to allow it to be replaced with fresh water, only when it is needed. Therefore, you may notice your cooler draining water occasionally. How often the WaterManager® performs this operation depends upon the quality of the water supply and the rate of evaporation.

In areas of poor water quality, the WaterManager® will operate more often as it tries to maintain the optimum water quality in the cooler. This maximises the cooling effect and life of the cooling pads.

The remote control has a unique feature attached to the WaterManager® that allows you to specify either high or low salinity settings. The low salinity setting is used in specific circumstances only. We recommend talking with your dealer before adjusting this setting.





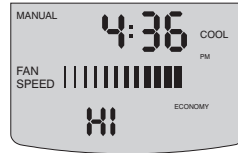

ILL1111-A

The high salinity setting is designed to operate the cooler at a maximum safe salinity level to maintain a normal working life. It also results in a minimum usage of water .



ILL1110-A

NOTE: High salinity outlet water should not be used on salt sensitive grass or plants. It has a high salt content.

The current WaterManager® setting is displayed by holding down the  button and pressing the  button. The setting can be changed by holding down the  button and pressing either the  or  button for HI and LO respectively.

The factory default WaterManager® setting is HI. For areas operating with bore water, DIP switch F should be switched to off (see page 10). This will disable the salinity measuring circuit and simply drain water from the tank every 65 minutes of operation.

BATTERIES

If the batteries are installed when the display is completely blank, the display will remain blank for 5 seconds. After 5 seconds the display will show "Id" for 1 second, then display the clock. The remote control is now ready to use.

The remote control requires 3 AAA batteries. The use of good quality alkaline batteries is recommended. Under normal conditions a set of batteries will operate for 18 months. Do not use rechargeable batteries as their voltage rating is too low for the remote control.

When the batteries are getting low on power, BATTERY LOW is displayed on the screen (the cooler may also switch off while the display remains ON). This indicates that the batteries have only a small amount of life remaining.

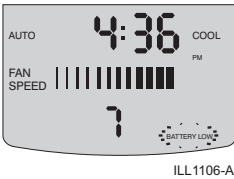

To change the batteries remove the cover from the back of the remote control. Pull out the old batteries and replace them all with the new ones. Do not mix new batteries with old batteries. The remote control has 2 minutes of back-up power to retain its memory while the batteries are being changed.

DIP SWITCHES

There are 2 rows of DIP switches located under the battery cover on the remote control.

WARNING: Do not alter DIP switches 1 to 10 as the cooler will cease to work.

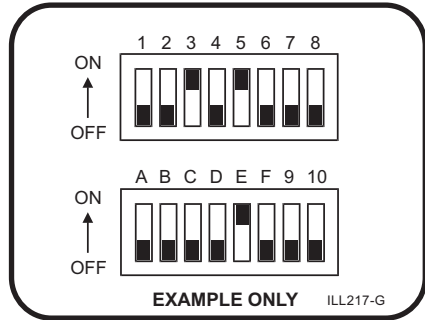

Definition of DIP switch positions (first 6 in bottom row only) are as follows:

- (A). Reserved for later use.
- (B). OFF, 24 hour clock.
ON, 12 hour clock.
- (C). OFF, 1100 / 1500W motor.
ON, 380 / 550 / 750W motor.
- (D). OFF, no pre-cool.
ON, pre-cool.
- (E). OFF, drains 3 days after power off.
ON, drains 3 hours after power off.
- (F). OFF, drains every 65 minutes of operation.
ON, activates water salinity circuit (WaterManager®).

TURNING THE COOLER ON

The wall control can be switched on and off by pressing the  button. The wall control will remember the previous setting it was in when the cooler was last used.

PREPARING TO START

Whenever you select AUTO mode or COOL in MANUAL mode, the cooler will take a few minutes to start as it fills with water and saturates the cooling pads. The time will be decreased if the tank is full or the cooler has only recently been turned OFF. During this time PREPARING TO START will flash on the display.

MANUAL MODE

With the wall control switched ON, press the  button until MAN is shown on the display.

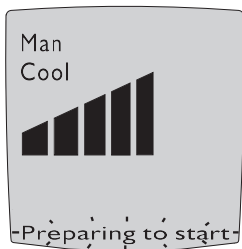

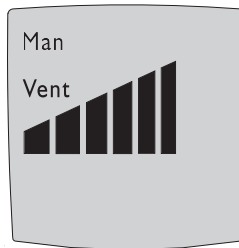

ILL1122-B

You may then press the  button to switch between COOL and VENT (where fresh air is being delivered but not cooled).



ILL1123-B

Once COOL or VENT has been selected, the wall control will maintain a constant fan speed. This is indicated by the bar graph shown on the display.



To increase or decrease the fan speed required, press either the  or  button.

AUTO MODE

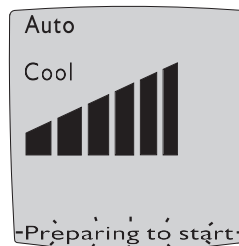
To select the AUTO mode press the  button until AUTO is shown on the display.



ILL1124-B



In AUTO mode the cooler will remember the last setting used and try to achieve this. It may vary depending on the day's conditions. Press the  button if you require more cool air or the  button if you require less. Don't alter the setting however, until the room temperature has stabilised.

DELAYED START OR STOP

The cooler can be programmed to start at a specific time or stop at a specific time.



The delayed start time can only be programmed when the cooler is OFF. To program the cooler to start in a certain amount of hours use the following sequence:

Programming in manual mode

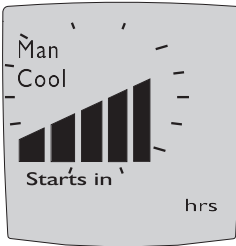

- (1)..... Press the **TIMER** button.
- (2)..... Press the **AUTO** button until MAN is displayed on the screen.
- (3)..... Press the  or  button until the desired fan speed is displayed by the bars in the middle of the screen.



ILL1118-B

- (4)..... Press the **COOL** button to set either COOL or VENT.
- (5)..... Press the **TIMER** button and the 'starts in' time will start flashing. Use the  and  buttons to select the desired time.
- (6)..... Press **TIMER** again.

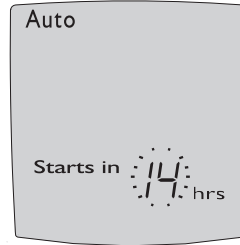

Programming in auto mode

- (1)..... Press the **TIMER** button.
- (2)..... Press the **AUTO** button until AUTO is displayed.
- (3)..... Press the **TIMER** button and the 'starts in' time will start flashing. Use the  or  button to select the hour.
- (4)..... Press **TIMER** again.



ILL1117-B

The delayed stop time can only be programmed once the cooler is ON. This is ideal if you are going to bed but don't want to turn the cooler off straight away. To program the delayed time in which you want the cooler to stop use the following sequence:

- (1).....Select the **TIMER** button and the 'stops in' time will start flashing. Use the  and  buttons to select the desired off time.
- (2)..... Press **TIMER** again.

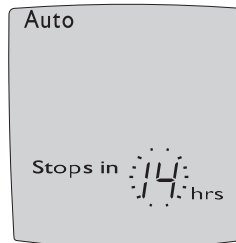

ILL1119-B

SERVICE MODE

When a fault has been recognised by the wall control the word SERVICE flashes on the screen.

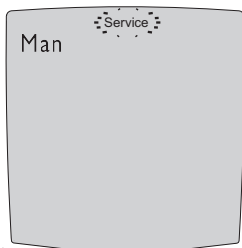

ILL1120-B

When SERVICE is displayed it may be necessary for you to phone the Service number located on the back of this manual. However, before doing so, turn the wall control OFF. You will notice a number flashing at the bottom of the screen. This number indicates the reason for requiring service.

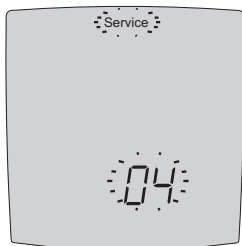

ILL1121-B

Please write this number down, then push the  button to turn the cooler back on. If after a short time SERVICE is again shown on the display, turn the wall control OFF and check if the flashing number is the same. If it is check the following possible problems. However, we do suggest that any checks be carried out by an authorised dealer or service agent.

If '02' is displayed



- (1).....Check that the water supply tap to the cooler is turned on.
- (2).....Check that your local water authority haven't temporarily disconnected the water in your area.

If '04' is displayed

- (1)..... If your cooler is fitted with a drain valve, check that the drain is not blocked.

If these do not fix the problem then contact your Dealer or the Service number on the back of this manual. You will need to quote the flashing number that you wrote down.

DRAIN MODE (Cooler switched OFF)

Pressing the  and  buttons at the same time for 2 seconds will open the drain valve and empty the water in the tank. The wall control will display DR on the screen. Draining the water will leave the tank clean and dry until it is next used.





CHANGING THE DEFAULT PARAMETER SETTINGS

The following operating parameters can be adjusted using the wall control but only if a drain valve has been fitted to your cooler.

SALINITY CONTROL METHOD SELECTOR

This parameter controls the following 2 options. Value 0 uses the intelligent WaterManager® which measures and controls the water's salinity level. Value 1 drains the tank every 65 minutes when the cooler is ON. Value 0 is the preset and preferred setting.

To change the salinity control setting use the following sequence:





- (1).....With the wall control turned OFF, hold down the  button. Continue to hold this button down and press the  button. The current setting and the 3 right most fan speed bars will be displayed.
- (2).....Press the  or  button to scroll through the various setting options discussed previously.
- (3).....When the desired setting is displayed, press the  button to store the new setting.

TANK DRAIN DELAY

This parameter changes the time before the tank is emptied of water, after the cooler has been turned off. The 5 options available are:

- 0 = 4 hours
- 1 = 1 day
- 2 = 2 days
- 3 = 3 days (default)
- 4 = 4 days.

To change the tank drain delay use the following sequence:

- (1).....With the wall control turned OFF, hold down the  button. While holding down this button press the  button. The current setting and 3 central fan speed bars will be displayed.
- (2).....Press the  or  button to scroll through the available settings.
- (3).....When the desired setting is displayed, press the  button to store the new setting.

Your cooler is fitted with one of two water management systems designed to control the water salinity and optimise the life of the pads in your cooler.

BLEED SYSTEM

If fitted, the bleed system, pictured on page 16, will constantly drain small amounts of water during the operation of the cooler. This allows fresh water to be added diluting any minerals and salts accumulated.

The bleed rate for your cooler will depend on local operating conditions and will be set by the installer.

DRAIN VALVE

If your cooler has been installed with a drain valve it is accompanied by the WaterManager® salinity probes. When the tank's water salinity level reaches a preset level the WaterManager® will open the drain valve and release about 6 to 8 litres. Fresh water will then be added diluting any minerals or salts accumulated. The Water Manager® will continue to monitor and drain water as required.

Alternatively, the cooler can be set to drain 6 to 8 litres of water at a preset period of pump operating time. This can be set by changing the salinity control method selector if using the wall control, or DIP switch F if using the remote control.

NOTE: When the cooler's tank is empty and the cooler is turned on again, the fan operation will be delayed as the tank is refilled and the pads are saturated.

POWER OUTAGES

If the power in your home goes off for less than 5 seconds the cooler will retain its current settings. That is, it will stop for the time the power is off but resume operation when the power comes back on again.

If the power goes off for more than 5 seconds the cooler will automatically turn itself off. That is, once the power comes back on the cooler will not resume operation. You will have to turn the cooler back on using the wall control or remote control.

Seasonal maintenance is only required if you have a cooler fitted with a bleed system. The following pages outline the maintenance required at the end of the season and then at the start of the next season. This ensures that your cooler continues to operate efficiently.

If your cooler is fitted with a drain valve no seasonal maintenance is required. However, we require that the following components and the operation thereof, be checked after the first year, then every 2 years as routine maintenance.

- (1)..... Belt drive.
- (2)..... Pump.
- (3)..... Drain valve.
- (4)..... Solenoid and associated filter.
- (5)..... Fan motor operation and current.
- (6)..... Float valve.

Note! Routine maintenance may be required more frequently in adverse environmental situations and very dusty areas.

WARNING

As your cooler is mounted on the roof, we suggest that any maintenance or checks be carried out by an authorised Breezair dealer or service agent. Climbing onto the roof can be hazardous and could result in injury to you and damage to your property.

Failure to carry out regular maintenance will affect your warranty coverage.

HEALTH REGULATIONS

In some states, regulations require that evaporative air coolers be serviced at specific intervals.

END OF SEASON

- (1).. Turn off the water supply to the cooler.
- (2)...Remove the pad frames as shown on page 17.
- (3)...Turn off the power at the isolating switch inside the cooler.
- (4)...Check and clean the water distributing channels under the lid.
- (5)...Unclip and remove the bleed system as shown below. Take care not to lose the o-ring. This removal will allow the water to drain from the tank throughout the winter.

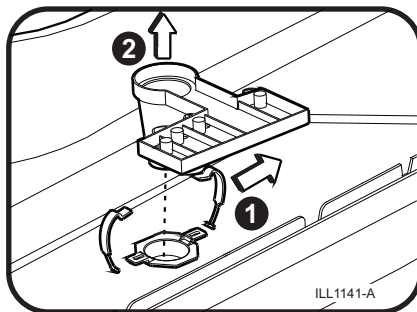

- (6)...Thoroughly clean the tank and the pump filter. Do not replace the bleed system. If you do, water will sit without draining from the tank throughout the winter months.
- (7)... Refit the pad frames.

PRE-SEASON

- (1)...Turn your main switchboard power off.
- (2)...Remove the pad frames as shown in the next column.
- (3)...Ensure the power is off at the isolating switch inside the cooler.
- (4)...Gently wash the pad frames to remove any dust build up during the winter. **NOTE: Do not wash the pads with high pressure water spray.** If the pads are salted-up replace them.
- (5)...Replace the bleed system that was removed at the end of the last season. Ensure that the o-ring is in place and that the tray is positioned so that it can catch the water from the pad.
- (6)...Turn on the water supply to the cooler.
- (7)...Check for water leaks. Check operation of float valve.
- (8)...Check if adj. required to belt drive. Reset motor amps.
- (9)...Switch on the isolating switch.
- (10)...Refit the pad frames.
- (11)...Turn the power on at your main switchboard.
- (12)...Run the cooler. **WARNING: Do not run the cooler with the pad frames removed.**

REMOVING PAD FRAMES

To remove a pad frame:

- (1)...Remove the clips holding the pad frame in place.
- (2)...Insert a flat head screw driver into the slot between the lid and the top of the pad frame. Lever it so the pad frame is released.

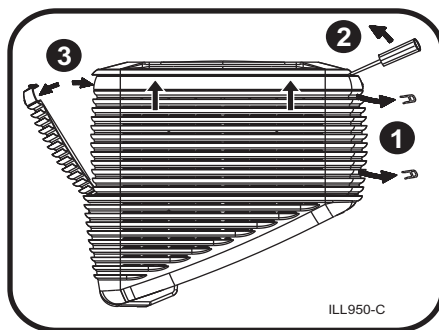

- (3)..... Take hold of the pad frame, pivot it outwards and lift it up. Be careful not to damage the pad.

Repeat the steps above with the 3 remaining pad frames.

(For EXH210 units only) There are 90mm pads fitted to the front and rear, with 100mm pads fitted to the sides (facing the fan scroll holes). These pads must be re fitted to their original positions, or the larger pads could catch on the float valve or components mounted on the scroll.

If fitted incorrectly, a drop in performance may be found, water can bypass the pad and be carried over into the airstream and ducting and/or damage to the pads or electronic components may occur.

The 100mm pads can be identified by a rebate at the base of the Chillcel.

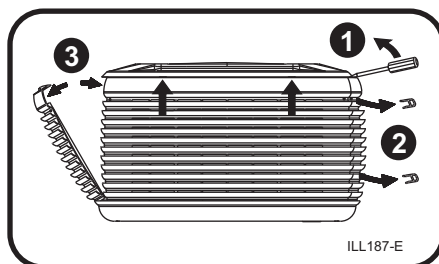

SYMPTOM

CAUSE

ACTION

Unpleasant odour.



Odour from the new pads.



Allow time to condition by running the cooler.

Inadequate cooling.



Dry pads.



Ensure the water supply is turned on. Then check the water flow to the pads.



Insufficient exhaust openings for conditioned air.



Ensure efficient openings. Refer to page 2.



Excessive ambient humidity.



On days during the summer when the ambient humidity is high, the cooler will not reduce the temperature as much as on drier days.

Remote control has no display.



Batteries are incorrectly fitted or they are flat.

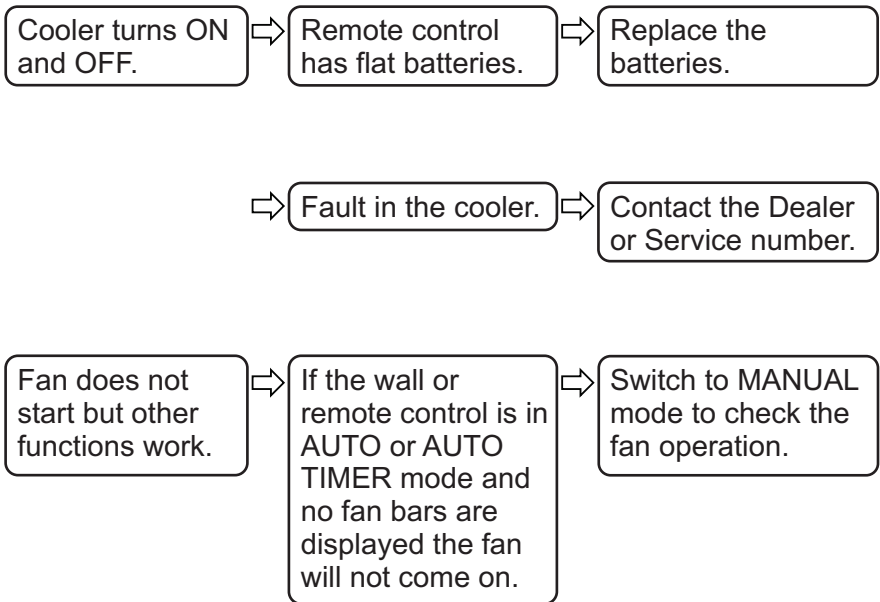

Refit or replace the batteries.

SYMPTOM**CAUSE****ACTION**

If your wall control displays SERVICE or should you consider that your cooler requires service, contact your local Dealer or the Service number on the back of this manual.

When you contact your Dealer regarding service or warranty please quote the cooler model number and serial number as shown below.

Affix serial & model
number sticker here

It is the policy of Seeley International to introduce continual product improvement. Accordingly, specifications are subject to change without notice. Please consult with your dealer to confirm the specifications of the model selected.



Warranty Service
Australia 1-300-650-644
seeleyinternational.com

Breezer®